

E4-WM5-Y344A00 MOUNTING INSTRUCTION



IMPORTANT! READ THIS FIRST

Installation of shock absorbers requires special tools and expert knowledge. Accordingly, installation of all BILSTEIN products must be performed by a qualified suspension specialist.

Always use a chassis hoist for the installation of BILSTEIN products and make certain that the raised vehicle is securely attached to the hoist and/or supported to prevent the vehicle from slipping, falling, or moving during the installation process.

If you choose to install any BILSTEIN product without the necessary special tools, expertise or chassis hoist, you may subject yourself to the risk of serious bodily injury or death. If you elect not to use a chassis hoist, at least make sure the vehicle is on level ground, that all tires on the ground during installation are blocked to prevent movement, that at least two tires are on the ground at all times, and that adequately secured safety stands (jack stands) are used to support the chassis. **NEVER** get under the vehicle until you have checked to make sure all of these steps are performed.

CAUTION!!!

Before disassembling the front suspension, refer to the vehicle manufacturer's Service Manual for proper procedures. The coil spring is preloaded and must be compressed with a spring compressor to release load before the upper mount is disassembled. Failure to follow the vehicle manufacturer's procedures may cause serious injury or death, and may damage the vehicle.

E4-WM5-Y344A00

MOUNTING INSTRUCTION



1. Disassemble front shock and coil spring according to vehicle manufacturer's procedures.
2. *(For height-adjustable shocks only—multiple grooves in shock body):* On the new Bilstein shock absorber, position the circlip in the desired ride height location**. **IMPORTANT:** Use appropriate tools to move the circlip. Ensure that the circlip is fully seated in the groove after moving it (you should be able to rotate it manually in the groove).
3. For non-height-adjustable shocks (single groove), do not remove the circlip from the groove.
4. Install the Bilstein supplied spring seat adapter as shown.

IMPORTANT: The circlip must fit completely in the groove inside spring seat adapter. Improper installation will cause permanent damage to the shock!

** Ride heights indicated are typical. Actual ride height is influenced by which factory suspension the vehicle is equipped with and its condition; optional equipment and accessories on your vehicle, and other vehicle modifications such as replacement coil springs, wheel and tire combinations, etc.

Modifying/lifting the suspension to your vehicle may raise its center of gravity and may make it more susceptible to loss of control and/or rollover, which may result in death or serious injury. We strongly recommend that you offset the loss of rollover resistance as much as possible by increasing tire track width, and that you equip the vehicle with a functional roll bar and cage system. Wear seat belts and shoulder harnesses at all times, and avoid situations where a side rollover may occur.

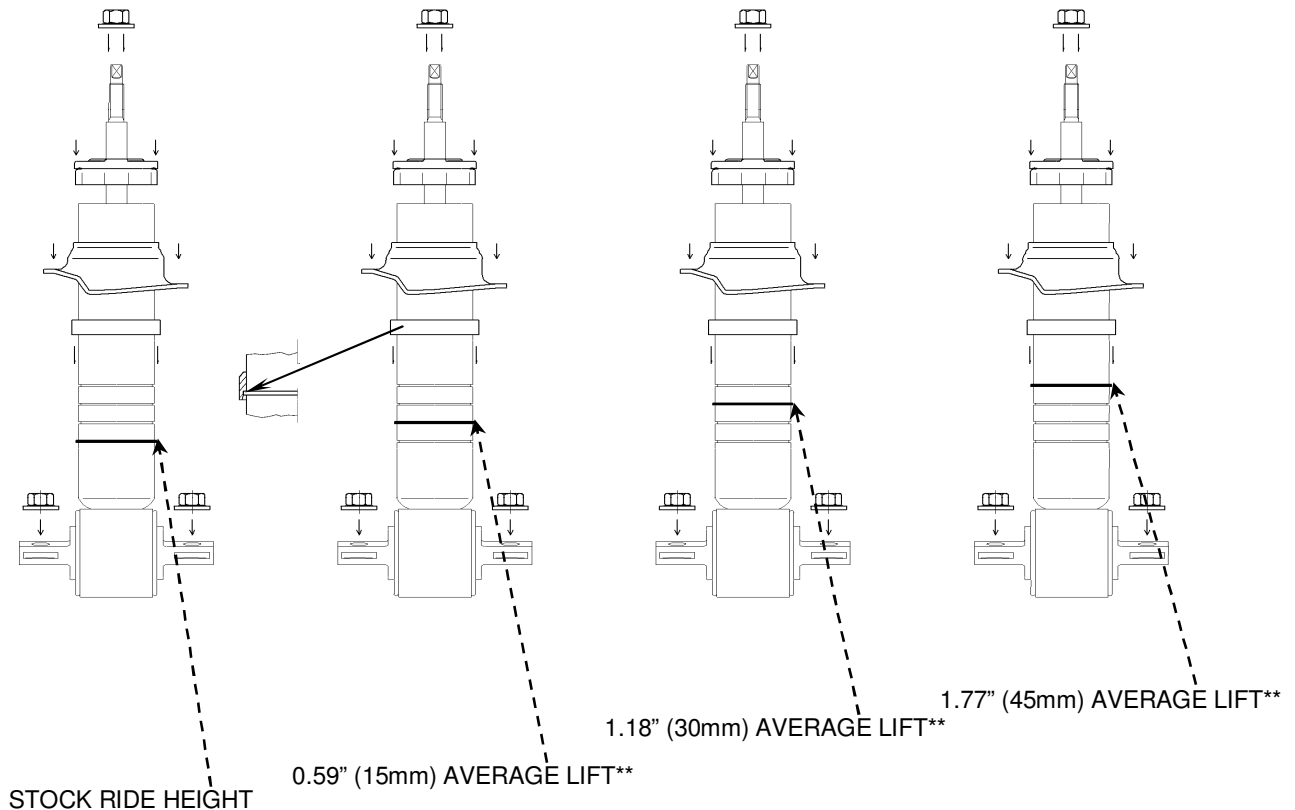

E4-WM5-Y344A00 MOUNTING INSTRUCTION



1. Reinstall OEM spring seat on supplied spring seat adaptor, Bilstein supplied bump stop cap, OEM coil spring, and all OEM upper mount parts including bump stop, and upper spring hat in their original positions. Install new flange nut (supplied) on the shock absorber top mount pin and tighten to 25 Nm (19 lb/ft).
2. Install new Bilstein supplied flange nuts on the lower T-Bar mount and tighten to 25 Nm (19 lb/ft). Do not re-use original lock nuts.
3. Check and adjust vehicle front-end alignment after installation.

