

1



Terminals and Connections?

H²O and baking soda



Corroded

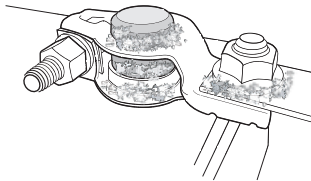

Clean

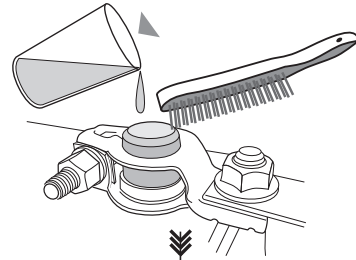

Loose

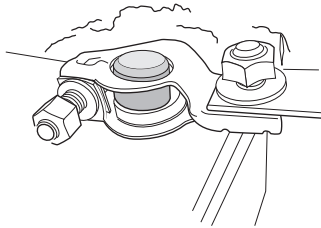

Tight

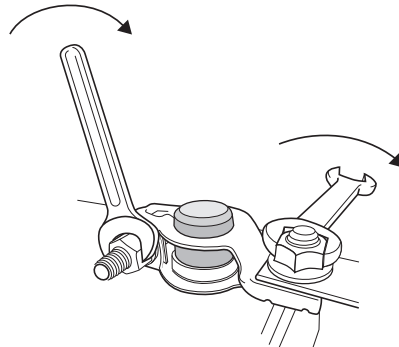

2



Battery Good or Bad?



Low charge

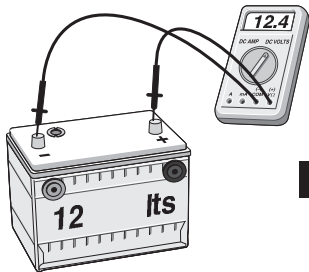

Good Charge

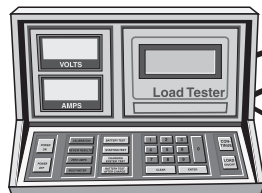
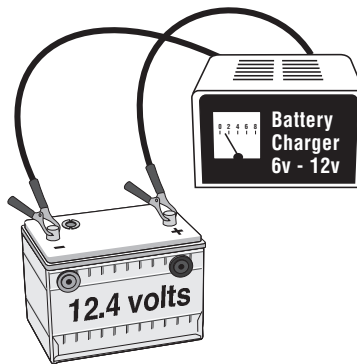

Test at parts store



Battery good



Replace battery

3



Starter Problem?

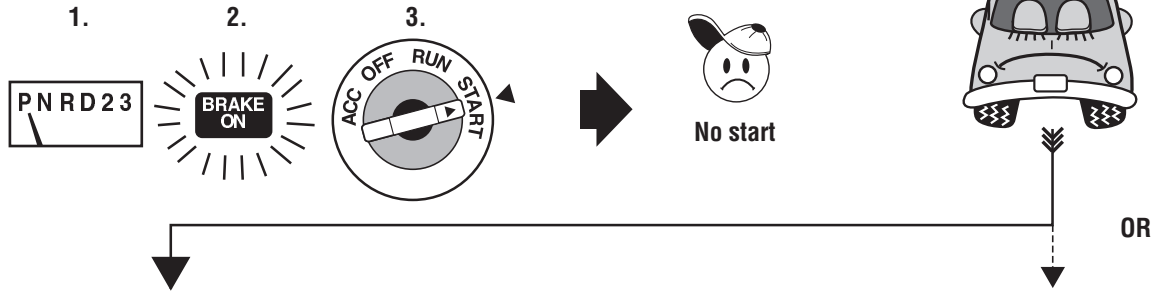

Ignition By-pass

Remote switch

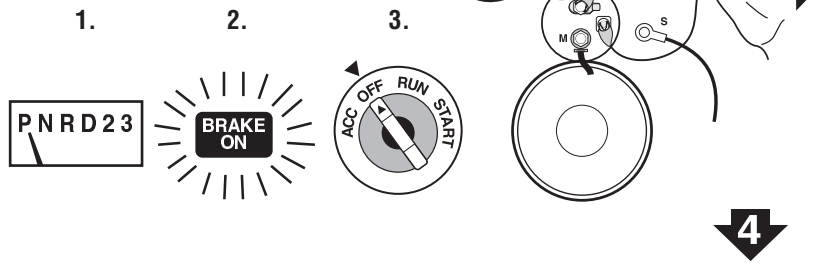

Possible starter replacement

Starter good. Go to step 4

4



Typical Starting System Checks

